

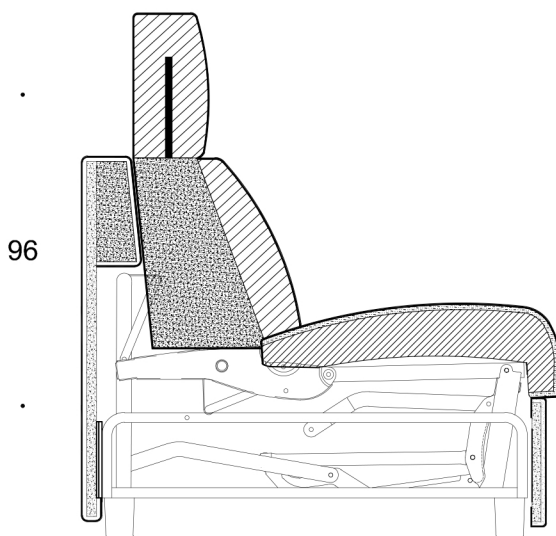

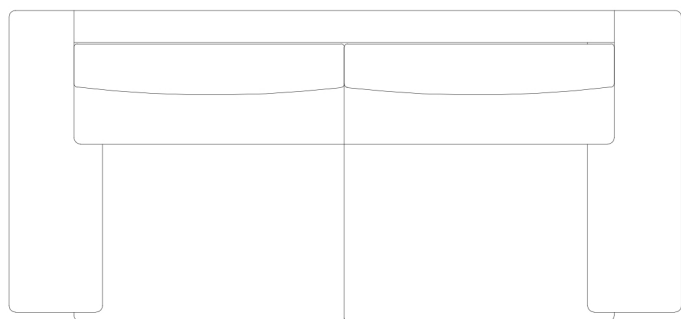

Boss

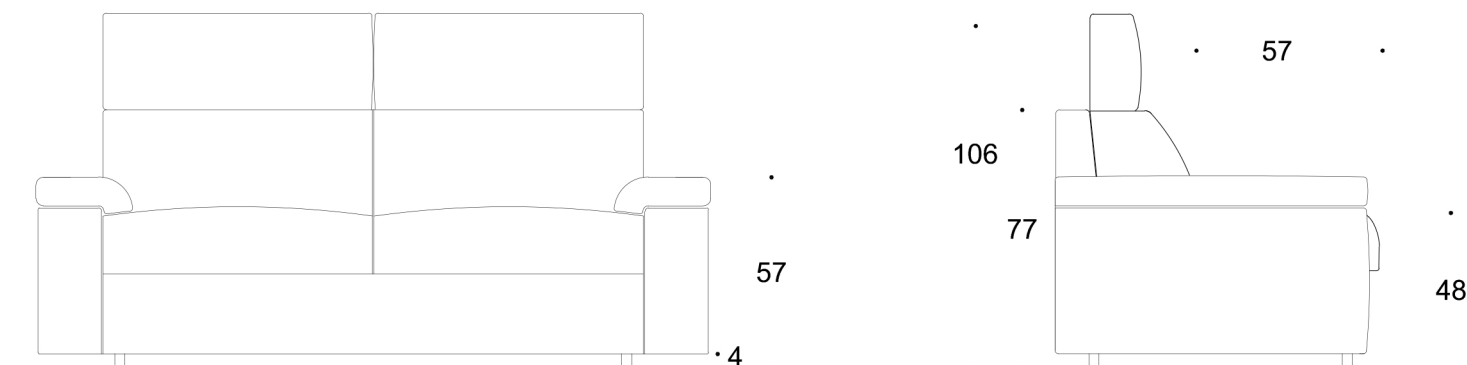



 Poliuretano indeformabile
30 Kg/MC

 Fibra siliconata
accoppiata 100 gr/mq

 Poliuretano
Sofficie 18Kg/MC

 Poliuretano
rivestito

 Poliuretano elastico
28Kg/MC

 Fusto in legno

 Fibra siliconata
200 gr/mq

 Tessuto / Pelle

216

